

GLASS RETAINER MOULDING

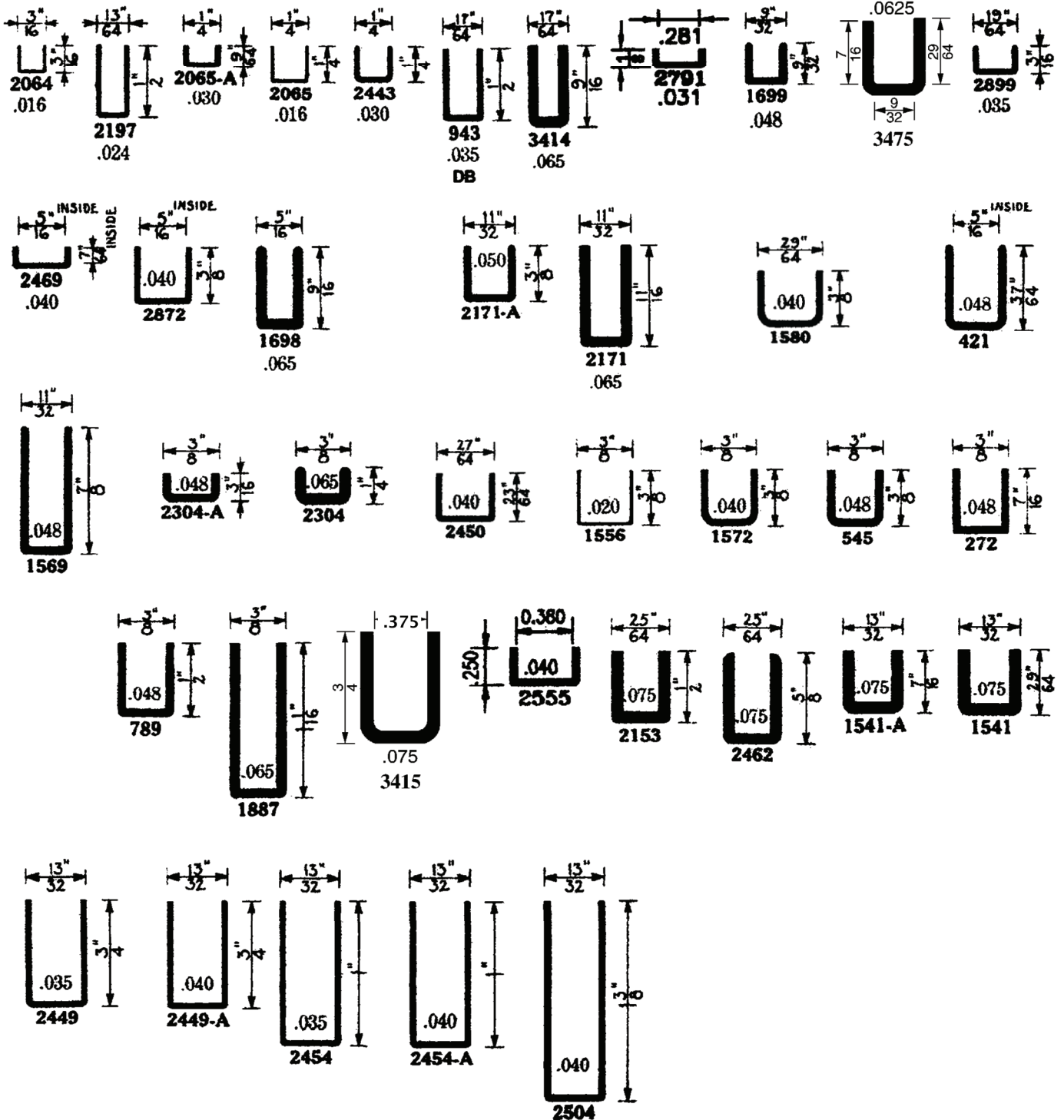

BULLETIN BOARD FRAME



222

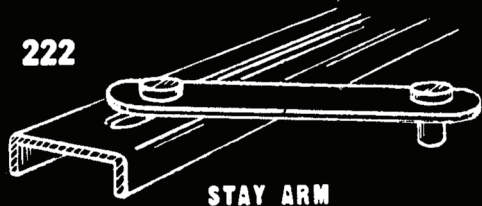

STAY ARM

1671

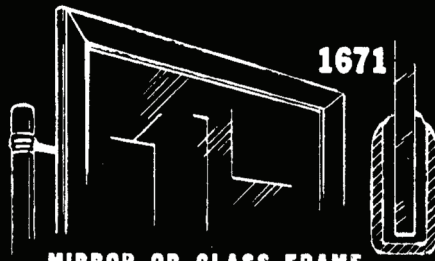

MIRROR OR GLASS FRAME

1353



FINNED RING

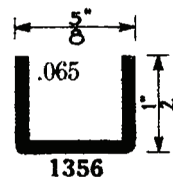
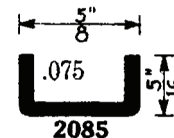
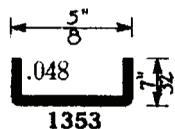
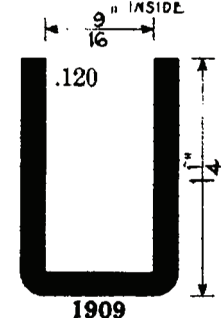
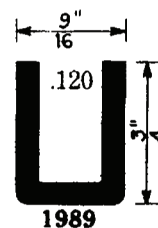
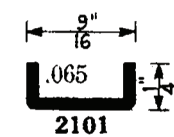
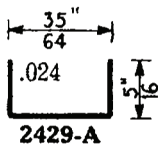
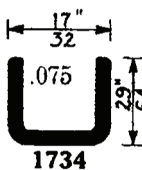
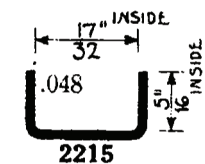
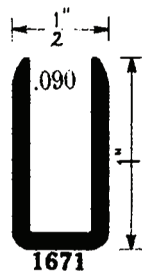
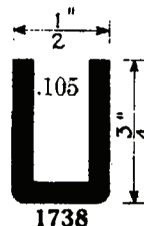
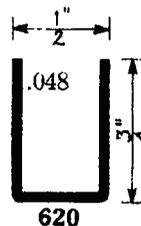
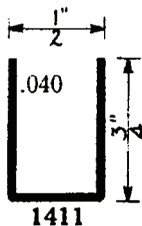
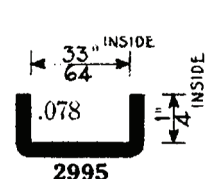
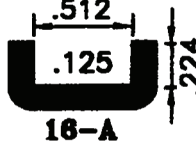
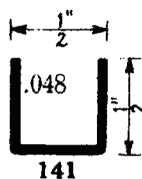
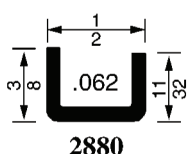
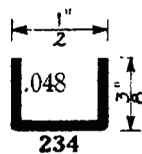
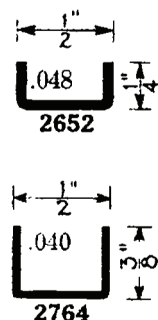
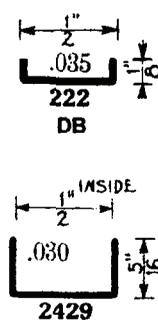
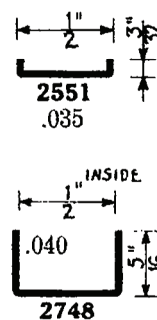
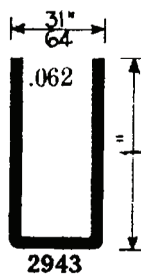
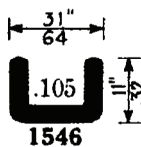
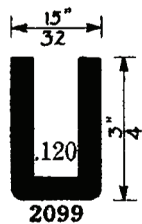

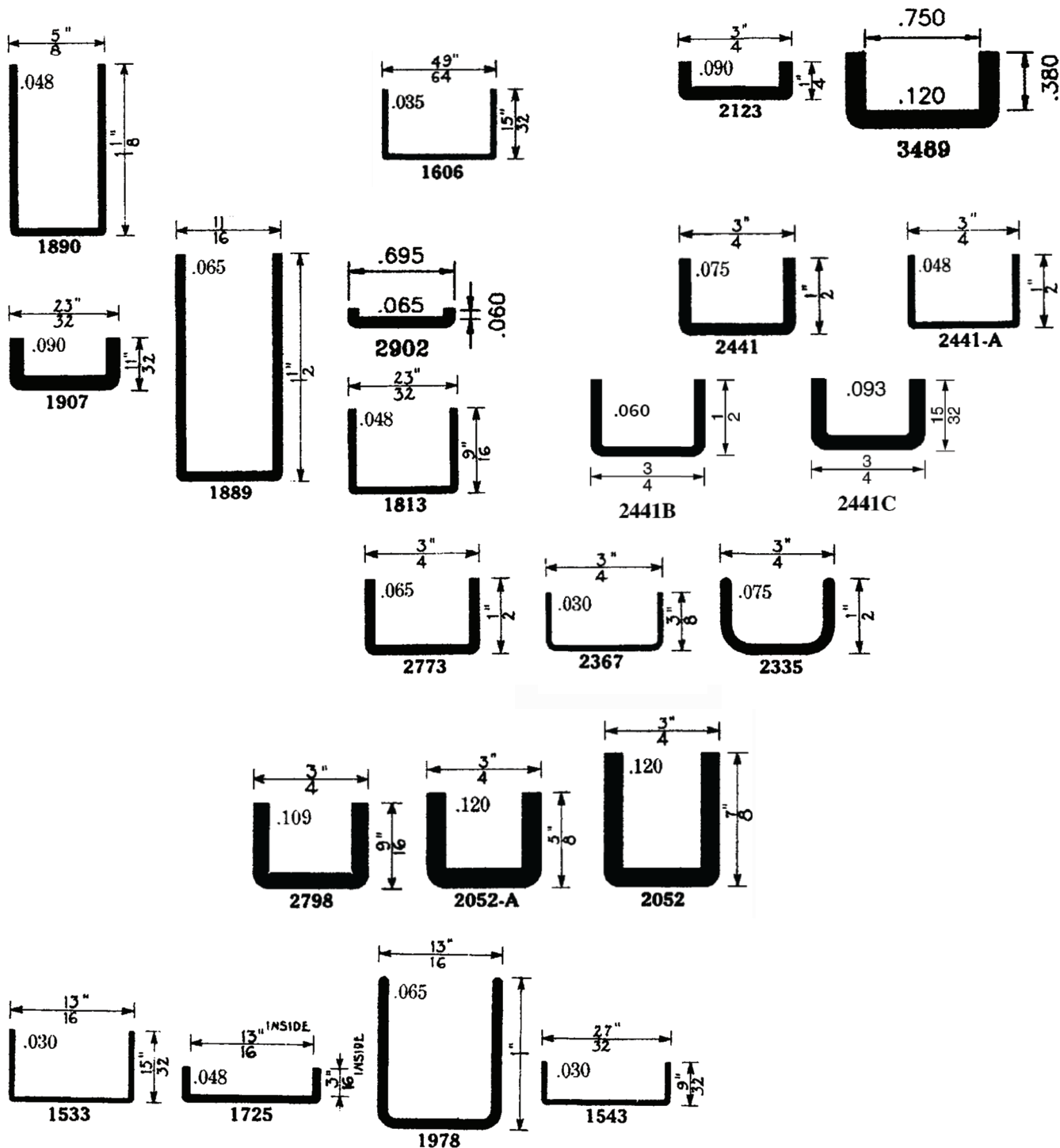
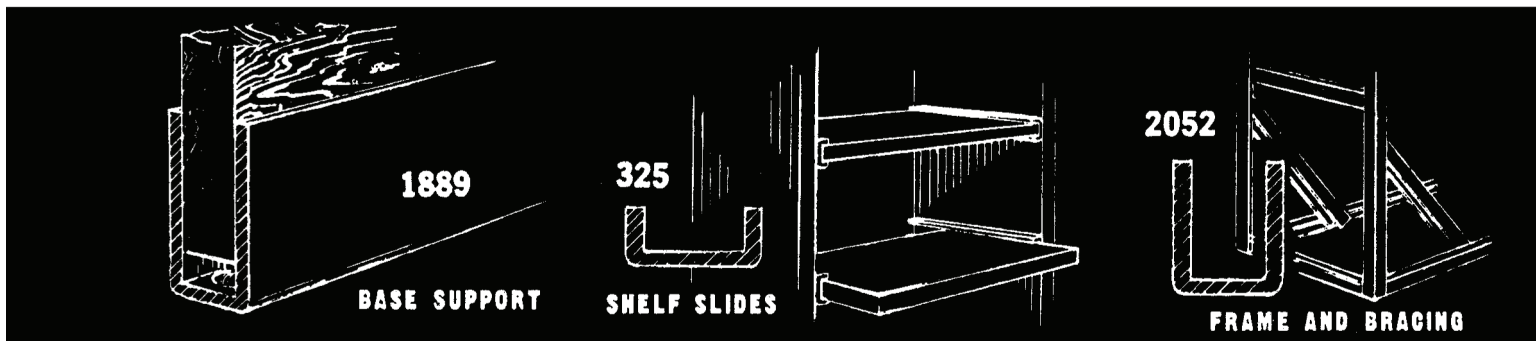

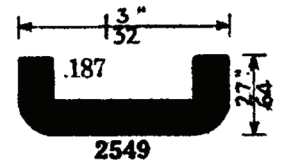
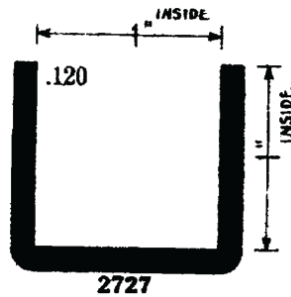
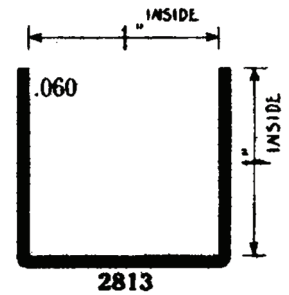
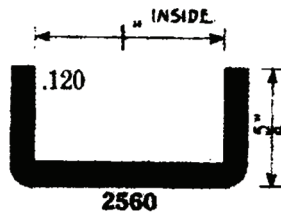
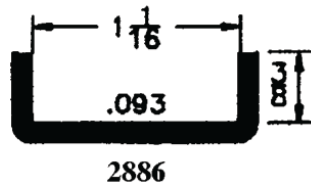
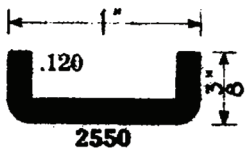
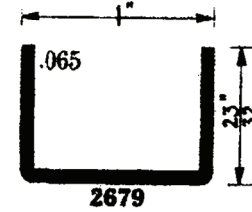
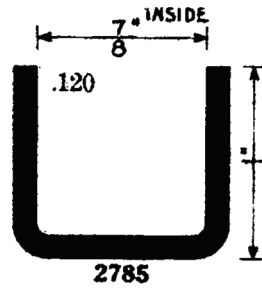
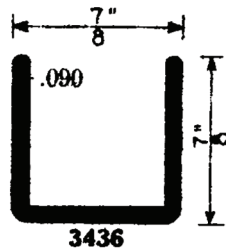
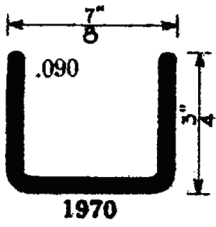
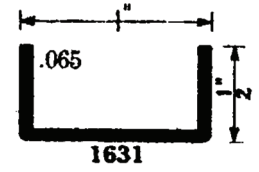
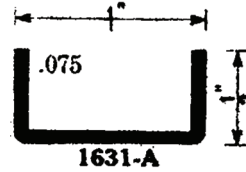
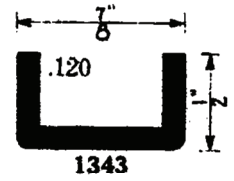
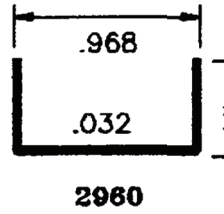
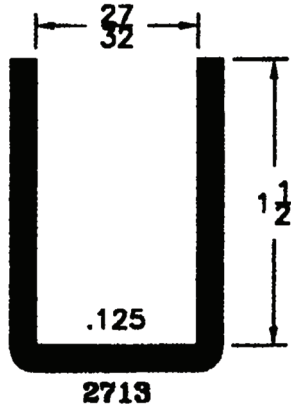
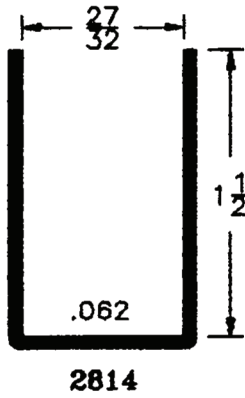
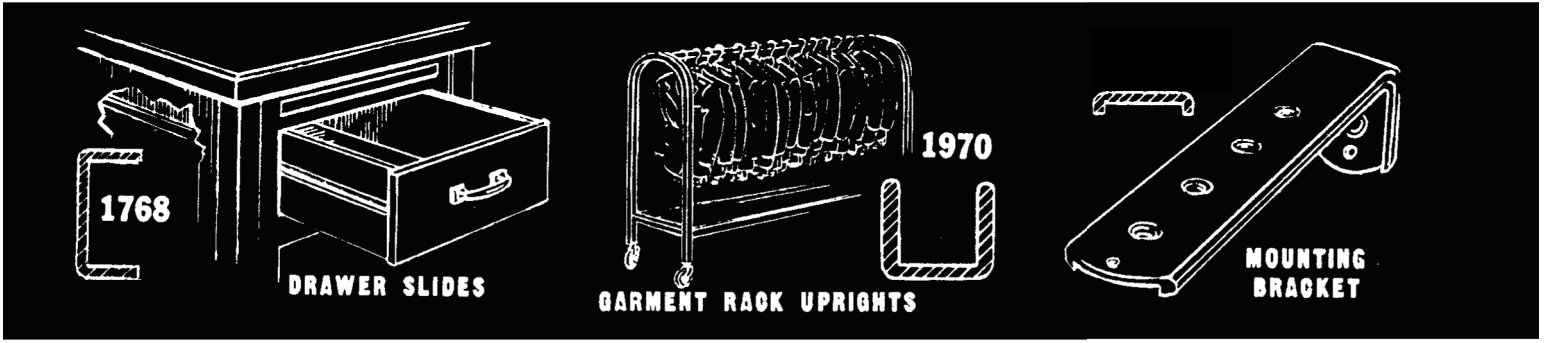

400 and 2623

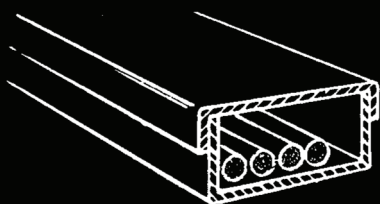

WIRE DUCT



2769

MACHINE GUARD

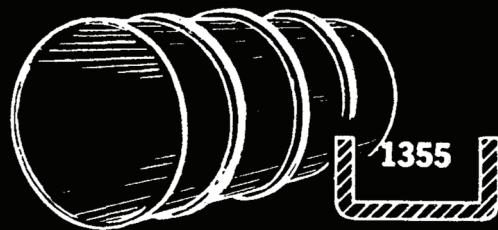

1355

CHANNEL REINFORCEMENTS

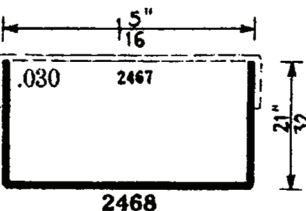
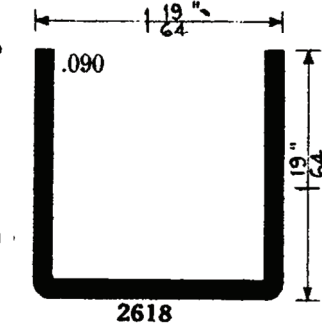
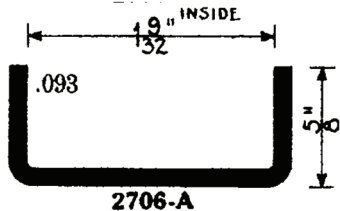
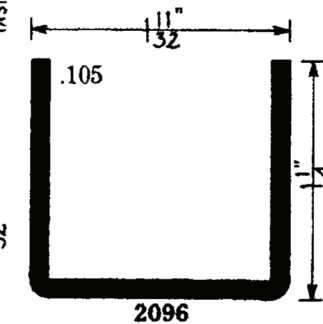
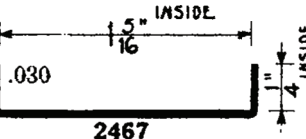
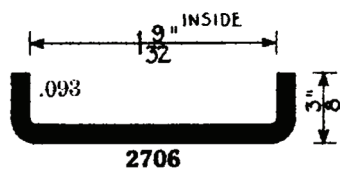
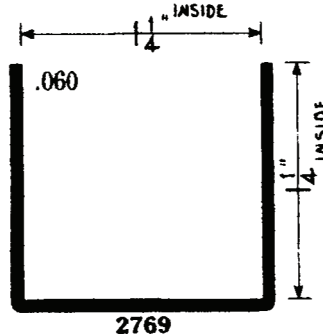
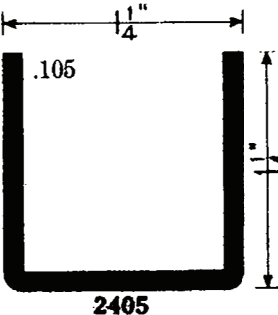
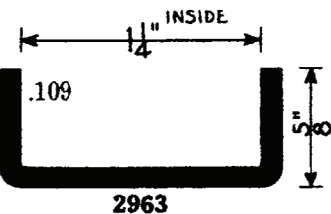
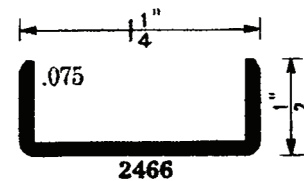
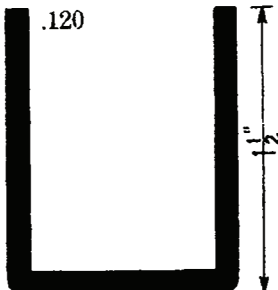
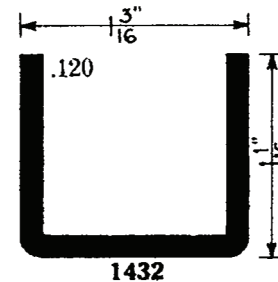
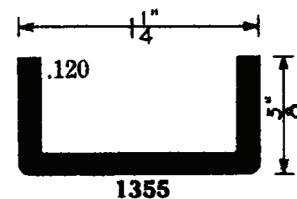
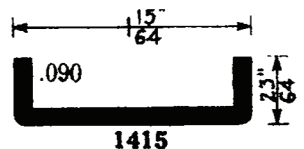
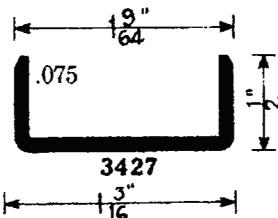
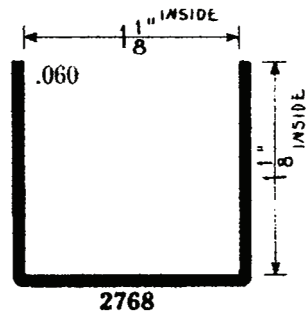
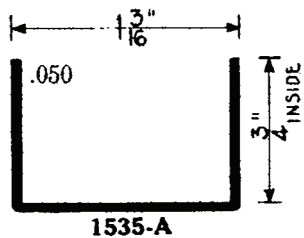
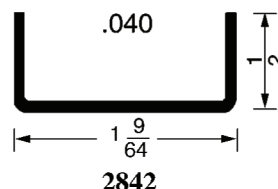
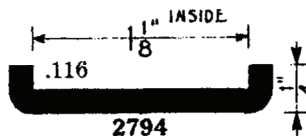
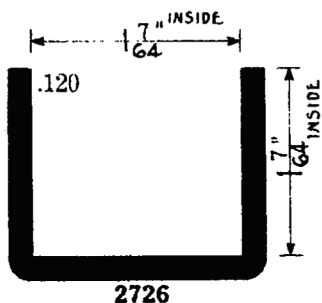
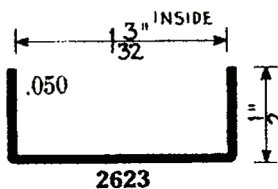

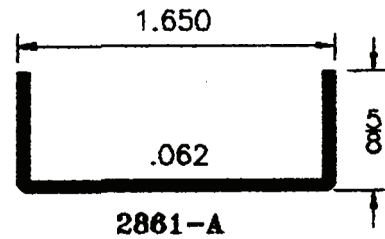
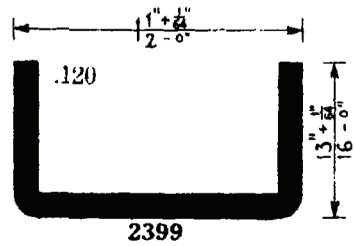
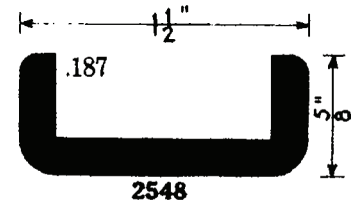
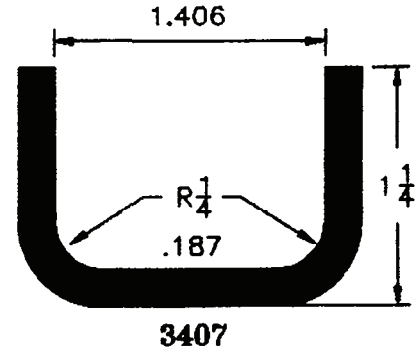
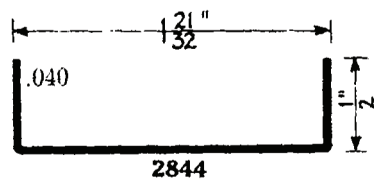
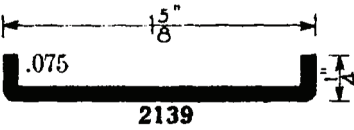
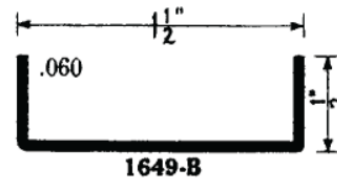
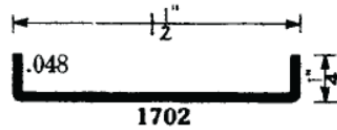
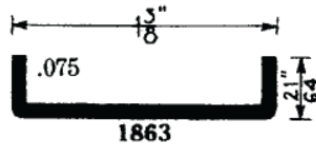
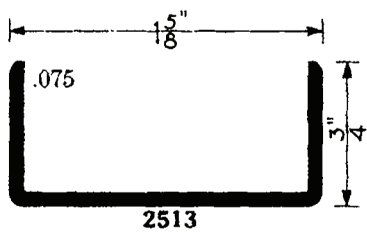
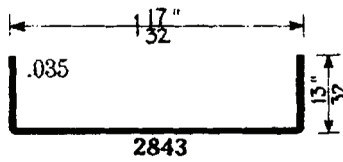
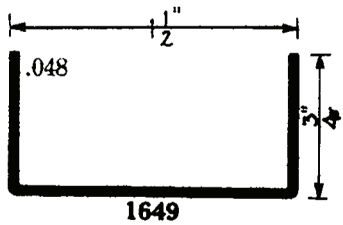
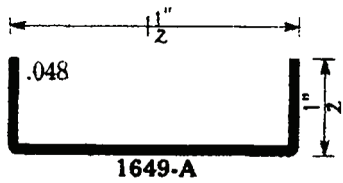
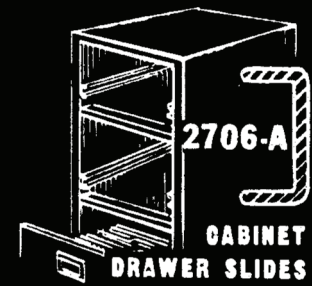
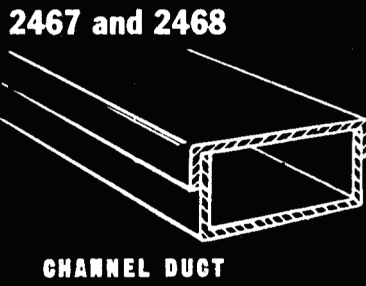
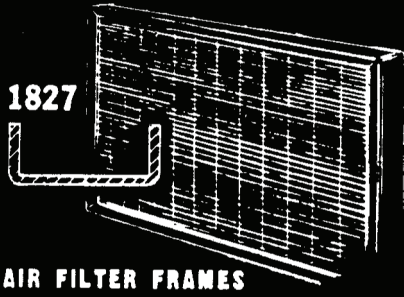



2676

COMPUTER  
CASE FRAME

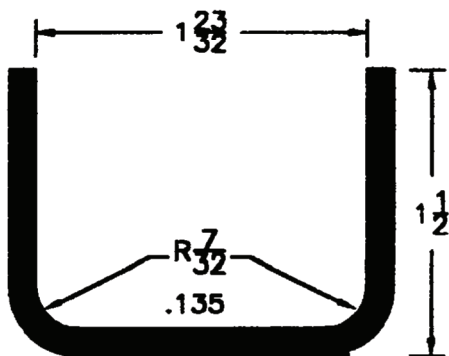
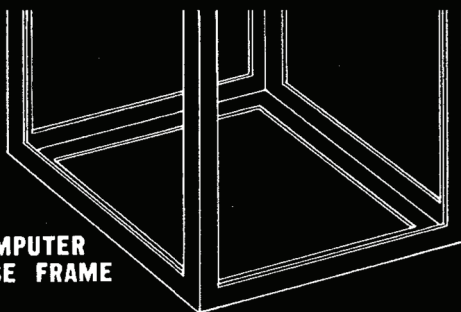

2474

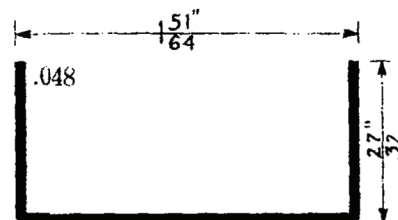

1951

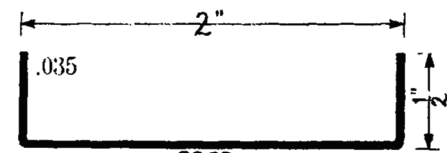

2363

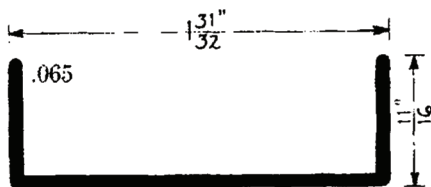

1942

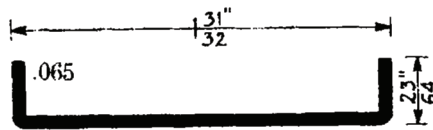

1893

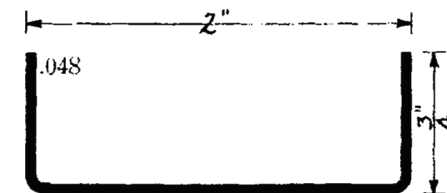

1827

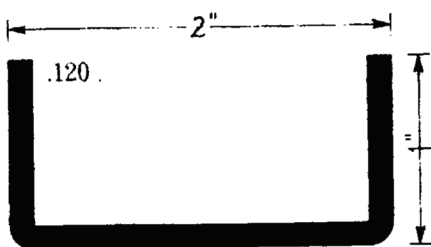

2676

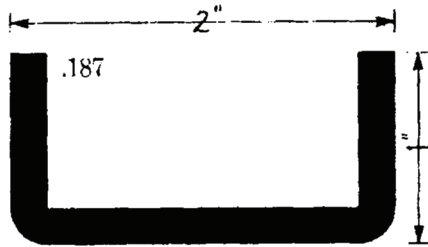

2799

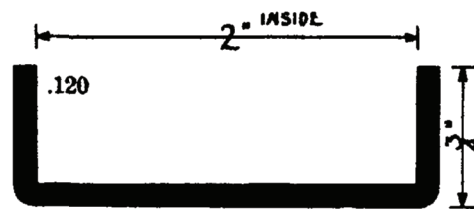

954

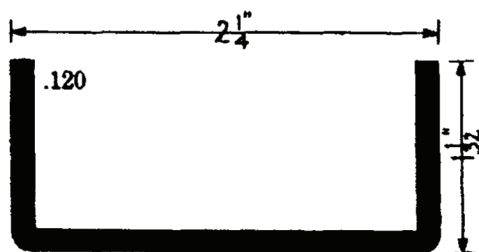

953 DB

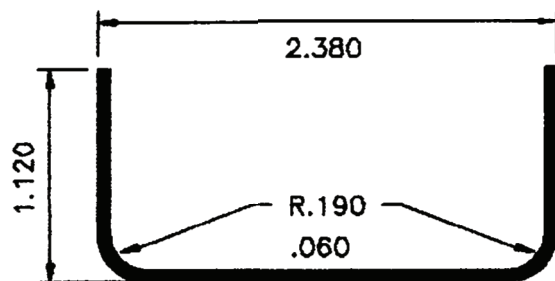

3499

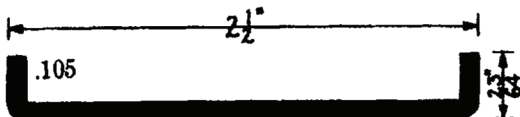

2309

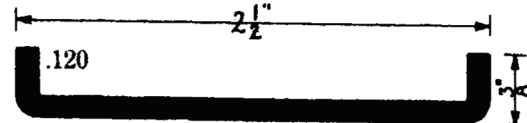

2309-A

